

ASSEMBLY INSTRUCTION

MORENO BENCH

ITEM CODE:71916

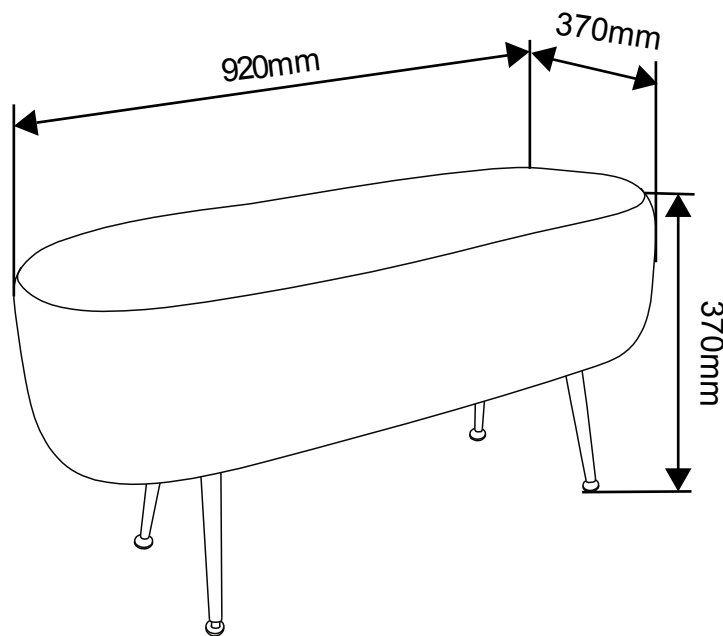



Imported by JWA Furniture Pty Ltd, Brisbane, Qld, Australia.

For any assistance with assembly or for missing parts please refer to your receipt



PRE-ASSEMBLY PREPARATION

Before you start:

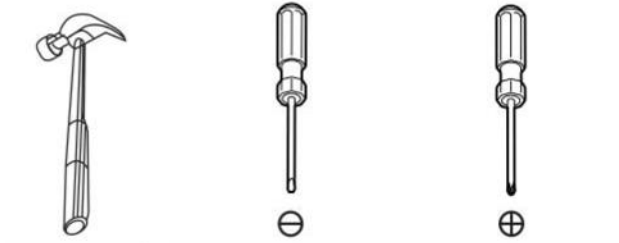
1. Choose a clean, level, spacious assembly area. Avoid hard surfaces that may damage the product
2. Take care when lifting. Product should be assembled as near as possible to the point of use
3. Ensure that you have all required contents for complete assembly
4. Always read the assembly instructions carefully before beginning assembly.
5. Keep all hardware parts and packaging out of reach of small children.
6. Do not over tighten the screws and bolts as this may damage the threads
7. Assembly is to be carried out by a competent adult(s) ONLY
8. During assembly, children should be kept away from the product due to possible risk to injury.
9. Do not use this item if any components are missing or damaged.
10. Please keep the instructions for future reference.

		
Allow 15 min	For 1 person	Additional tools required

PARTS LIST

A*16	B*1
 M6*18mm	 M6

Part	Description	QTY
1	Legs	4
2	Bench	1

①

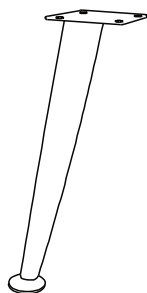

②

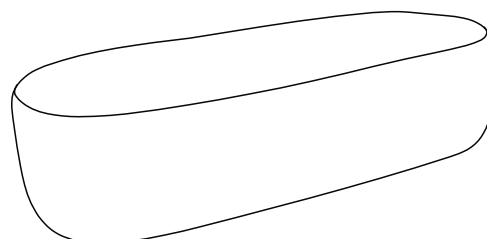

STEP 1:

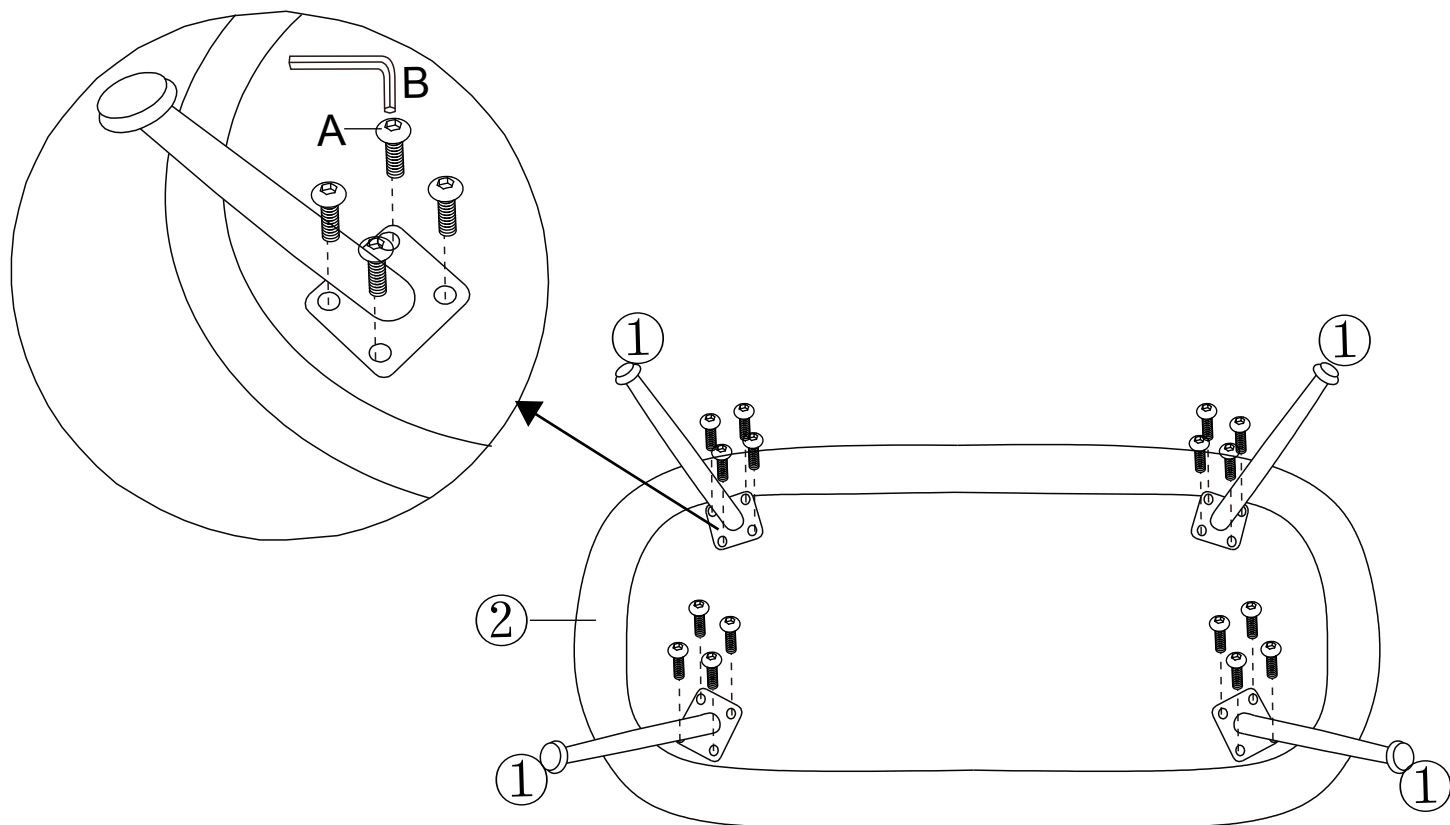

ASSEMBLY IS COMPLETE

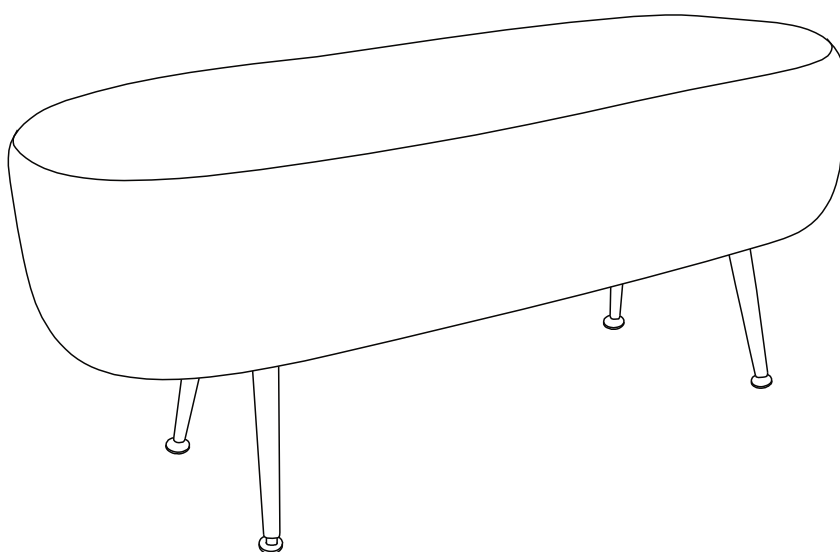

REGULAR CARE:

Protect from direct sunlight

Vacuum regularly using low suction

Rotate reversible cushions regularly

Avoid exposure to new clothing, cushions or throws as this may lead to dye transfer and permanent staining

CLEANING:

Do not remove cushion covers for separate cleaning even though they may have zippers

Do not wash, Do not dry clean, Do not shampoo clean

Clean only with hot water extraction machine. Professional cleaning recommended

Do not use dishwashing liquid or laundry detergent. Use only upholstery detergents

Do not wet filling

Dry in shade away from direct heat and sunlight

Allow to dry thoroughly before re-use

SPOT CLEANING:

Do not rub

Do not spot clean with any solvent

Treat spills and stains as soon as possible

Gently scrape off any soil or blot any liquid from the surface of the fabric before applying cleaner

Apply proprietary cleaning agents strictly according to instructions to remove the residue of the spill

Do not saturate the fabric or interior with water or other cleaning liquids

WARNING:

Apply only water-based soil resist (fabric protection) treatments. Do not use aerosol products

* PILLING IS NOT A FABRIC DEFECT OR FAULT AND IS NOT COVERED BY WARRANTY

* PILLING IS A NORMAL OCCURRENCE CAUSED BY WEAR AND TEAR AND DOES NOT AFFECT THE DURABILITY OR FUNCTIONALITY OF THE FABRIC AND IS EASILY REMOVED